

PART NUMBER: 20021/3-DP318

TITLE: 10+40kW COMBINER BRIDGE DIPLEXER (TRIPLE CAVITY)

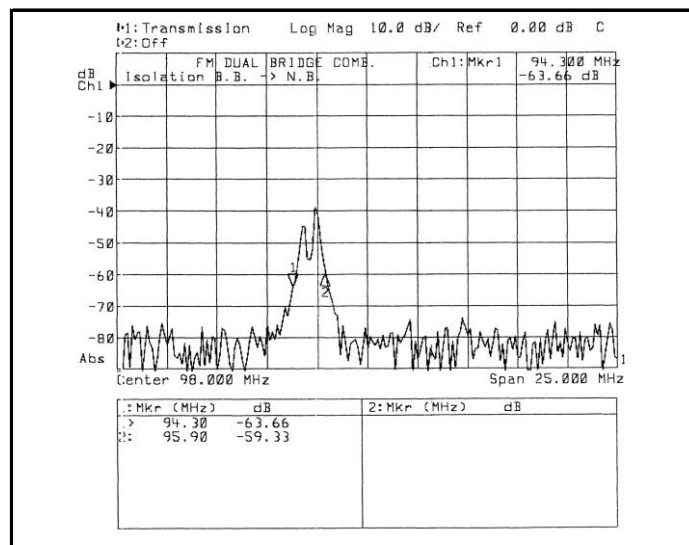
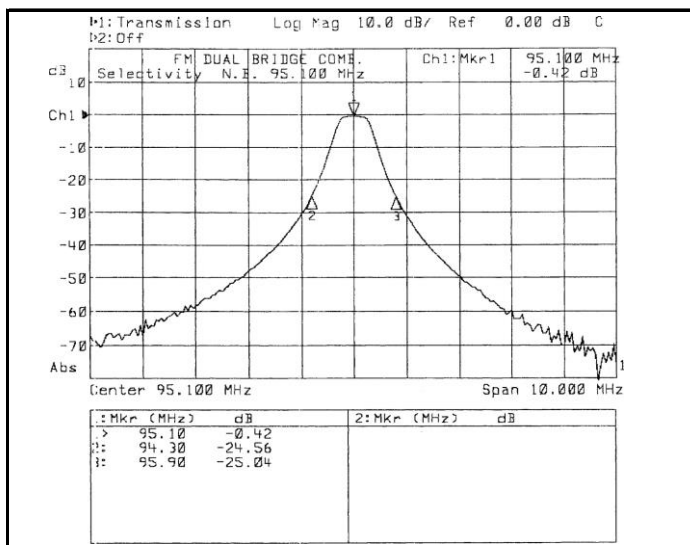
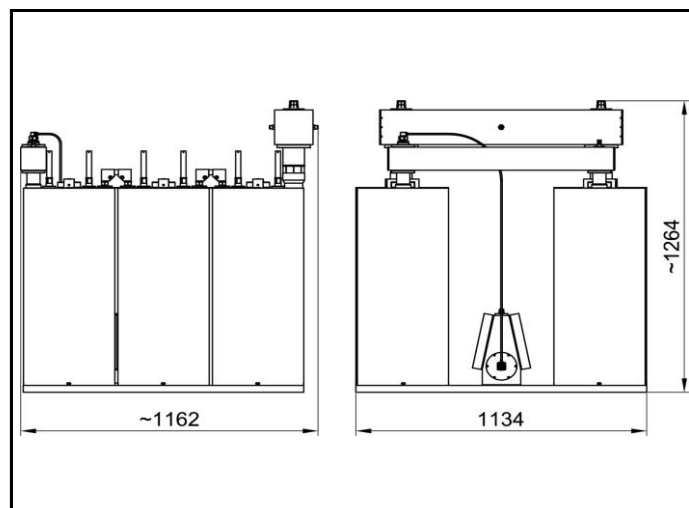

ELECTRICAL CHARACTERISTICS	
Frequency Range (MHz)	87.5 ÷ 108
N.B. Insertion Loss (dB)	< 0.5
B.B. Insertion Loss (dB)	< 0.2
Min. distance between channels (MHz)	0.8
Insulation NB>BB (dB)	> 40
Insulation BB>NB (dB)	> 50
Return loss by channels (dB)	> 26
Input/Output impedance (Ohm)	50
Narrowband maximum power (W)	10000
Maximum output power (W)	50000

MECHANICAL CHARACTERISTICS	
Input narrowband	EIA 1 5/8"
Input broadband	EIA 3 1/8"
Output	EIA 3 1/8"
Temperature range (C°)	-10 ÷ 50
Weight (kg)	170

(*) Different connectors on request.