

PART NUMBER:

1633-S4

TITLE:

**4x100W DOUBLE CAVITY BAND PASS FILTER STAR COMBINER
(ON RECEPTION OR TRANSMISSION)**

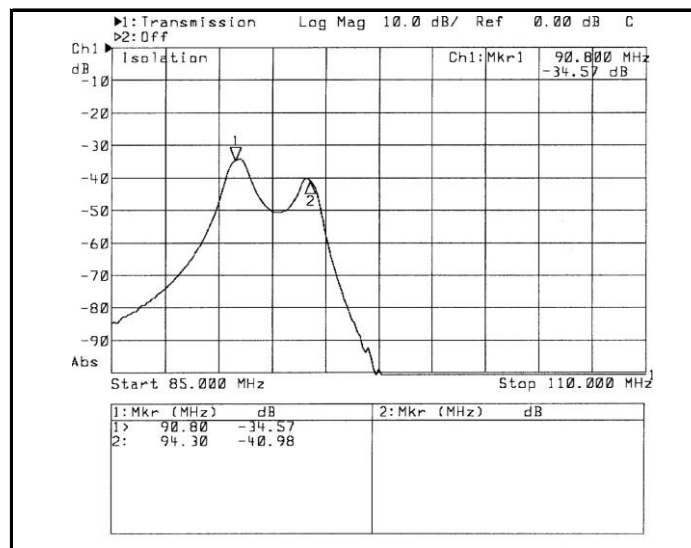
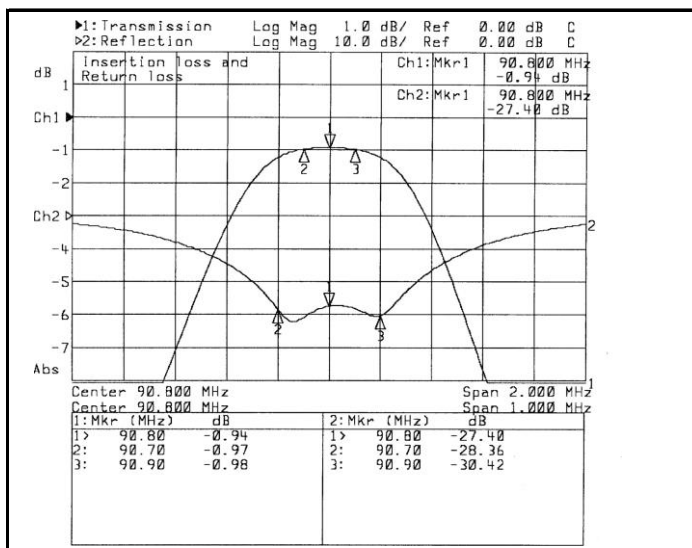
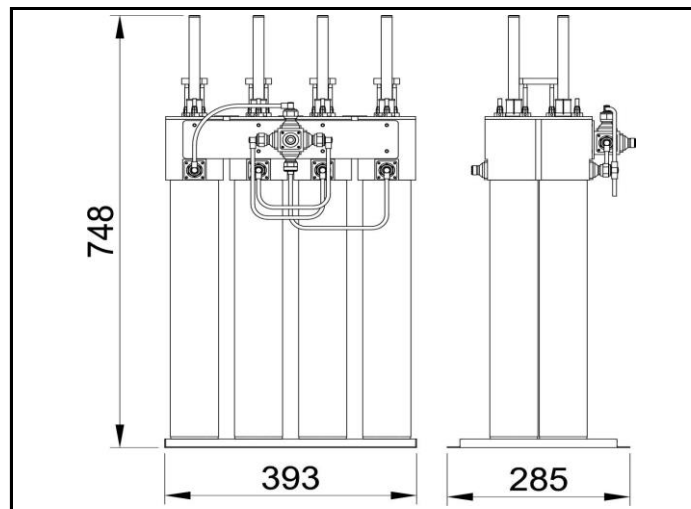

ELECTRICAL CHARACTERISTICS	
Frequency Range (MHz)	87.5 ÷ 108
Insertion Loss by channels (dB)	< 1.05
Return loss by channels (dB)	> 26
Input/output impedance (Ohm)	50
Min. distance between channels (MHz)	2
Insulation between channels (dB)	> 30
Maximum channel input power (W)	100
Maximum output power (W)	400

MECHANICAL CHARACTERISTICS	
Input connection	N
Output connection	N
Temperature range (C°)	-10 ÷ 50
Weight (kg)	25

(*) Different connectors on request.